

**Description**

Silicon PNP transistor in a SOT-23 Plastic Package

**Applications**

General purpose high voltage amplifier, Meet the stringent requirements of automotive applications

**Features**

- High voltage
- Complementary Pair with CTMMBT5551Q
- Qualified to AEC-Q101 Standards for High Reliability
- Halogen-free Product

**Equivalent Circuit & Pinning**

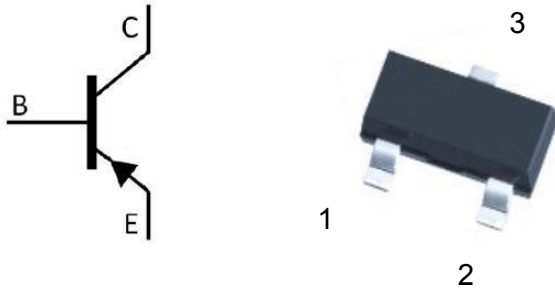

PIN1 : Base

PIN 2 : Emitter

PIN 3 : Collector

**hFE Classifications & Marking**

hFE Classifications Symbol	A	B	C
hFE Range	50~150	100~300	200~400
Marking	Q2LA	Q2LB	Q2LC

**Absolute Maximum Ratings(Ta=25°C)**

Parameter	Symbol	Rating	Unit
Collector to Base Voltage	$V_{CBO}$	-180	V
Collector to Emitter Voltage	$V_{CEO}$	-160	V
Emitter to Base Voltage	$V_{EBO}$	-6.0	V
Collector Current	$I_C$	-600	mA
Base Current	$I_B$	-300	mA
Collector Power Dissipation	$P_C$	300	mW
Junction Temperature	$T_j$	150	°C
Storage Temperature Range	$T_{stg}$	-55~150	°C

**Electrical Characteristics(Ta=25°C)**

Parameter	Symbol	Test Conditions	Min	Typ	Max	Unit
Collector to Base Voltage	$V_{CBO}$	$I_C=-100\mu A$ $I_E=0$	-180			V
Collector to Emitter Voltage	$V_{CEO}$	$I_C=-500\mu A$ $I_B=0$	-160			V
Emitter to Base Voltage	$V_{EBO}$	$I_E=-100\mu A$ $I_C=0$	-6.0			V
Collector Cut-Off Current	$I_{CBO}$	$V_{CB}=-180V$ $I_E=0$			-0.1	$\mu A$
Collector Cut-Off Current	$I_{CEO}$	$V_{CE}=-160V$ $I_B=0$			-5.0	$\mu A$
Emitter Cut-Off Current	$I_{EBO}$	$V_{EB}=-6.0V$ $I_C=0$			-0.1	$\mu A$
DC Current Gain	$h_{FE(1)}$	$V_{CE}=-5.0V$ $I_C=-10mA$	50	200	400	
	$h_{FE(2)}$	$V_{CE}=-5.0V$ $I_C=-50mA$	20	70		
	$h_{FE(3)}$	$V_{CE}=-5.0V$ $I_C=-1.0mA$	40	180		
Collector-Emitter Saturation Voltage	$V_{CE(sat)(1)}$	$I_C=-10mA$ $I_B=-1.0mA$		-0.12	-0.4	V
	$V_{CE(sat)(2)}$	$I_C=-50mA$ $I_B=-5.0mA$		-0.5	-0.8	V
Base-Emitter Saturation Voltage	$V_{BE(sat)(1)}$	$I_C=-10mA$ $I_B=-1.0mA$		-0.75	-1.0	V
	$V_{BE(sat)(2)}$	$I_C=-50mA$ $I_B=-5.0mA$		-0.8	-1.0	V
Base-Emitter Voltage	$V_{BE}$	$V_{CE}=-5.0V$ $I_C=-10mA$		-0.7	-0.75	V
Transition Frequency	$f_T$	$V_{CE}=-10V$ $I_C=-10mA$	50	80		MHz
Collector Output Capacitance	$C_{ob}$	$V_{CB}=-10V$ $I_E=0$ $f=10MHz$		2.5	5.0	pF
Turn-on Time	$t_{on}$	$I_C=-100mA$ $-I_{B1}=I_{B2}=-10mA$		0.1		$\mu s$
Storage Time	$t_{off}$			0.2		$\mu s$
Fall Time	$t_{stg}$			0.1		$\mu s$

Electrical Characteristic Curve

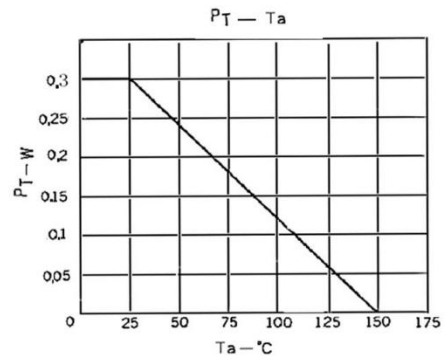
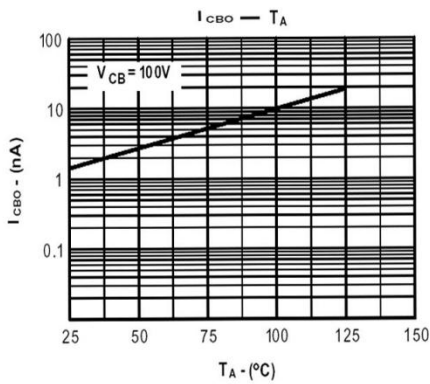
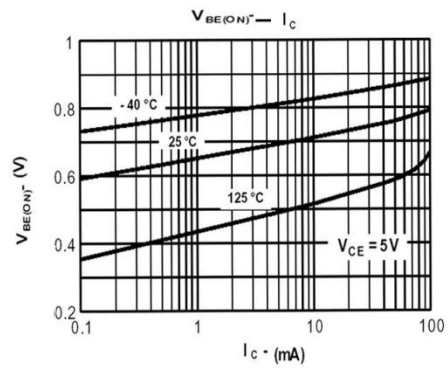
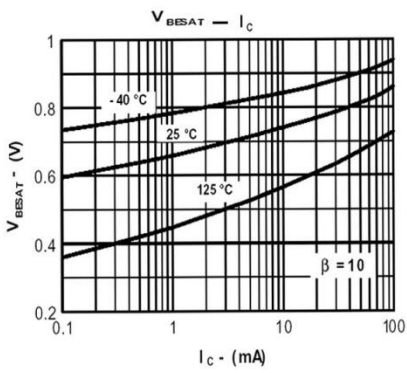
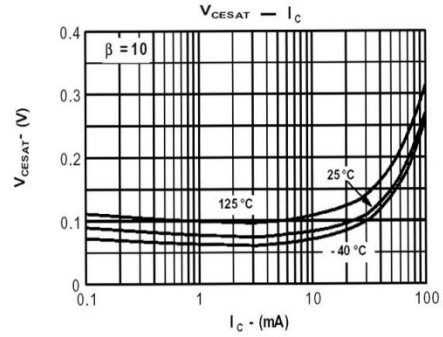
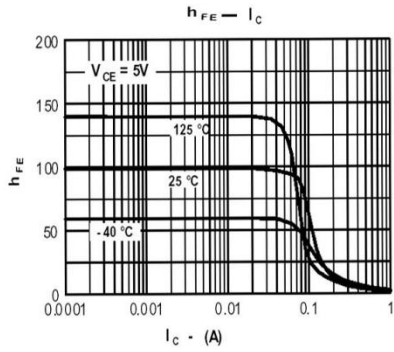

Marking Instructions



Note:

- Q: Automobile halogen-free product Code.
- 2L: Product Type Code
- A hFE Classifications Symbol Code

Packaging SPEC.

REEL INFORMATION

Package Type	Units					Dimension (unit: mm <sup>3</sup> )		
	Units/Reel	Reels/Inner Box	Units/Inner Box	Inner Boxes/Outer Box	Units/Outer Box	Reel	Inner Box	Outer Box
SOT-23	3,000	10	30,000	6	180,000	7" x8	180x120x180	390x385x205

Package Outline Dimensions

SOT-23

单位: mm

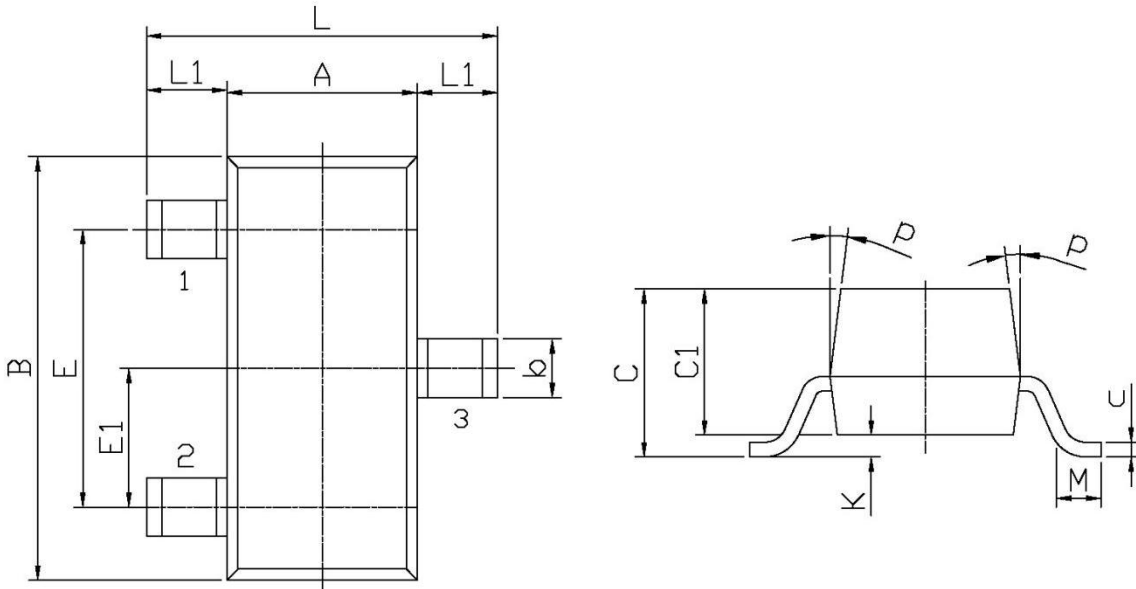

Symbol	Dimensions In Millimeters		Symbol	Dimensions In Millimeters	
	Min	Max		Min	Max
L	2.2	2.7	C	1.30Max	
L1	0.45	0.65	C1	0.90	1.20
A	1.15	1.50	c	0.05	0.20
B	2.70	3.10	K	0	0.10
E	1.70	2.10	M	0.20MIN	
E1	0.85	1.05	P	7°	
b	0.35	0.55			